

4100

profile

4100
405 gr/m

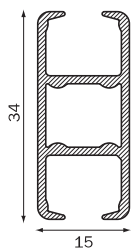

bending

radius

- R 15 (1015)
- R 20 (1015)
- R 30 (1015)
- R>80 (1018)

filler position

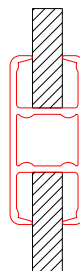

Mounting

ceiling and wall

4100

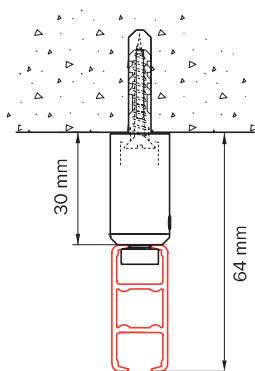

ceiling mounting with mini suspension hanger 4254

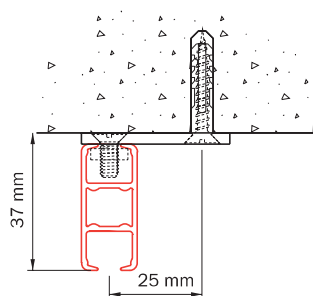

ceiling mounting with ceiling bracket 4135

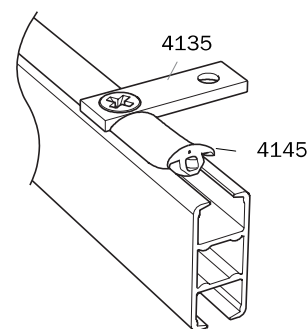

ceiling mounting with ceiling bracket 4135 and dust cover 4145 to seal the gap

wall mounting with extension bracket 4217

	a
4217-101	100
4217-201	200
4217-202	200

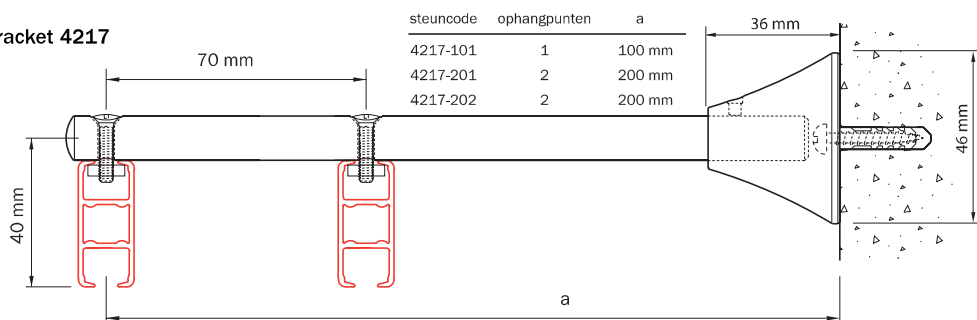

wall mounting with wall bracket 4149

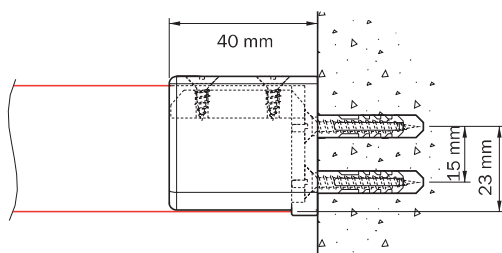

wall mounting with extension brackets 4115

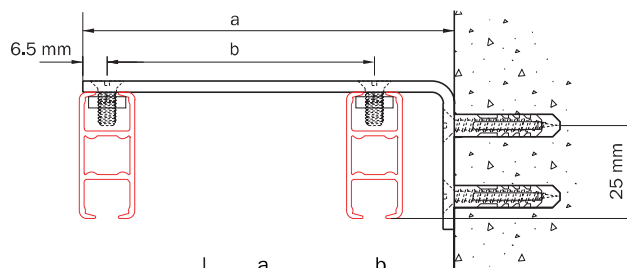

	a	b
4115-07.5	75	47
4115-10	100	72
4115-15	150	72

Application example

4100

G-Standard

