

# 2100/2102

## profile

**2100**  
109 gr/m

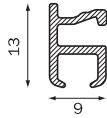

## bending

radius  
R 8 (1013)  
R 10 (1012)  
R 10 (1015)  
R >80 (1018)

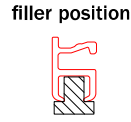

## profile

**2102**  
166 gr/m

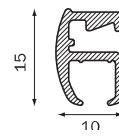

## bending

radius  
R 8 (1013)  
R 10 (1012)  
R 10 (1015)  
R >80 (1018)



# Mounting

## ceiling, wall mounting

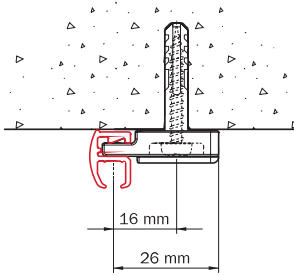

ceiling mounting with ceiling support 2150

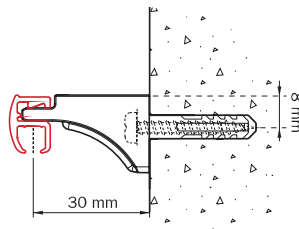

wall mounting with wall support 2151

## 2100 & 2102

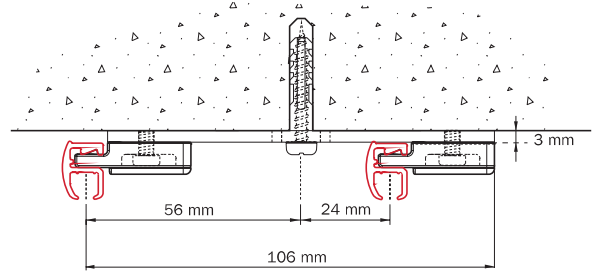

for perfect parallel mounting: use of double bracket 2216 with ceiling supports 2150

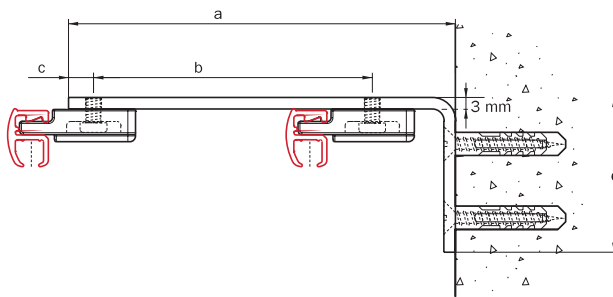

dimensions for wall mounting with metal extension brackets (see table) and supports 2150

in mm	a	b	c	d
2015-05	50	-	6.5	40
2105-07.5	75	47	6.5	40
2015-10	100	72	6.5	40
2015-15	150	72	6.5	40
2018-15	150	57/57	6.5	60
2019-20	200	80	6.5	60
2019-25	250	80	6.5	60
2019-30	300	80	6.5	60

# Application example

## 2102

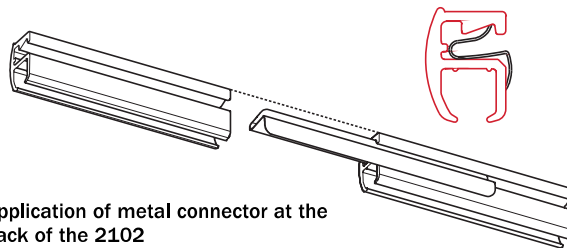
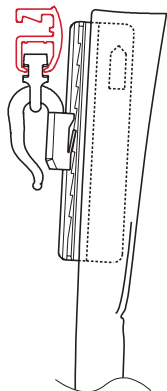

Application of metal connector at the back of the 2102

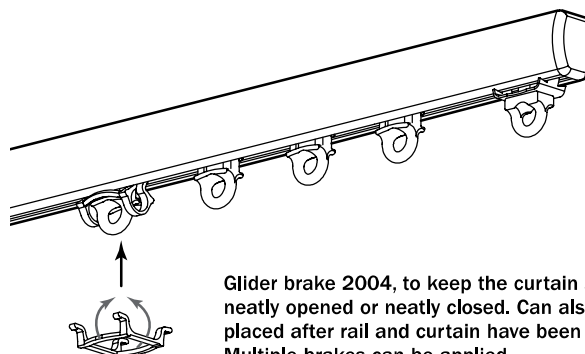

2102 (and 2100): suitable for a heading, with glider 2010 and adjustable sew in hooks

Glider brake 2004, to keep the curtain stack neatly opened or neatly closed. Can also be placed after rail and curtain have been fitted. Multiple brakes can be applied.

# G-standard

